



STEREO AMPLIFIER

SA-62000

EV NR

2

Switch circuit ass'y B AWS-044

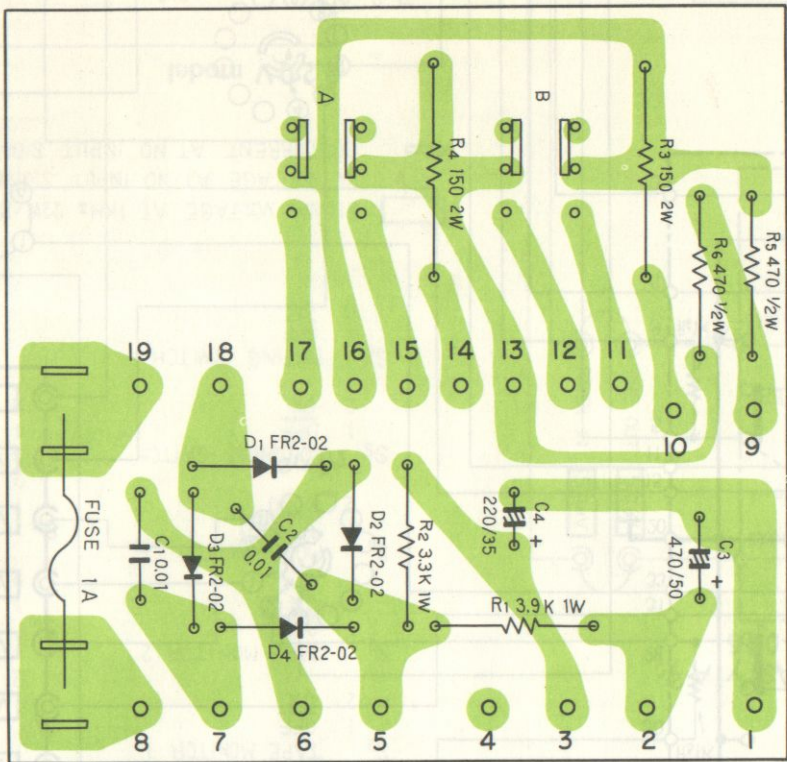

Control amp ass'y AWG-020

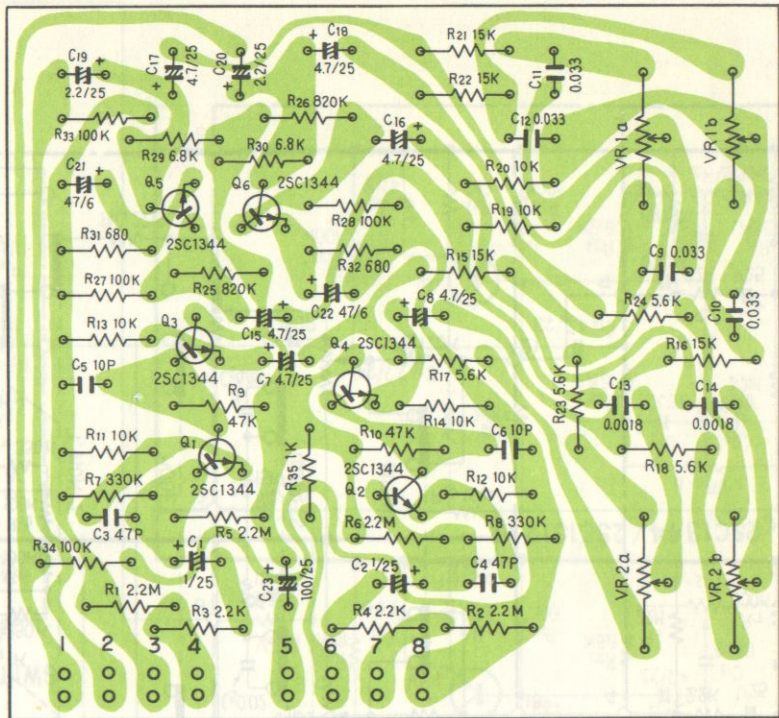

Switch circuit ass'y A AWS-045

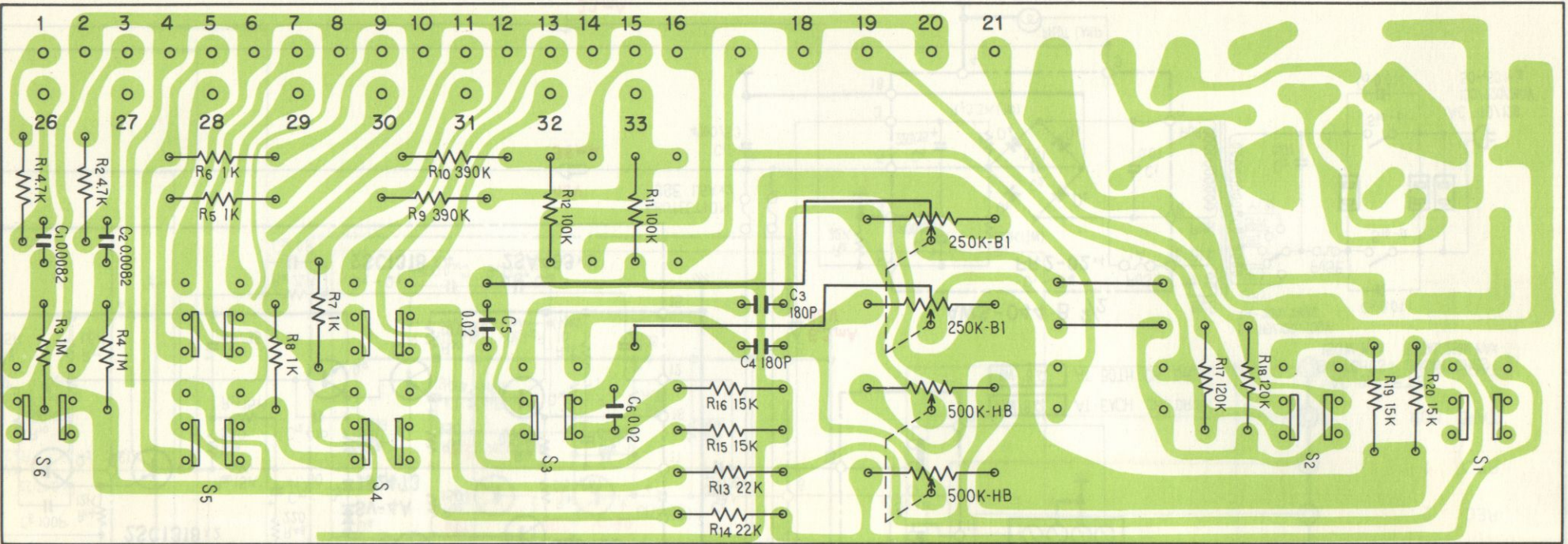

Equalizer amp ass'y AWF-008

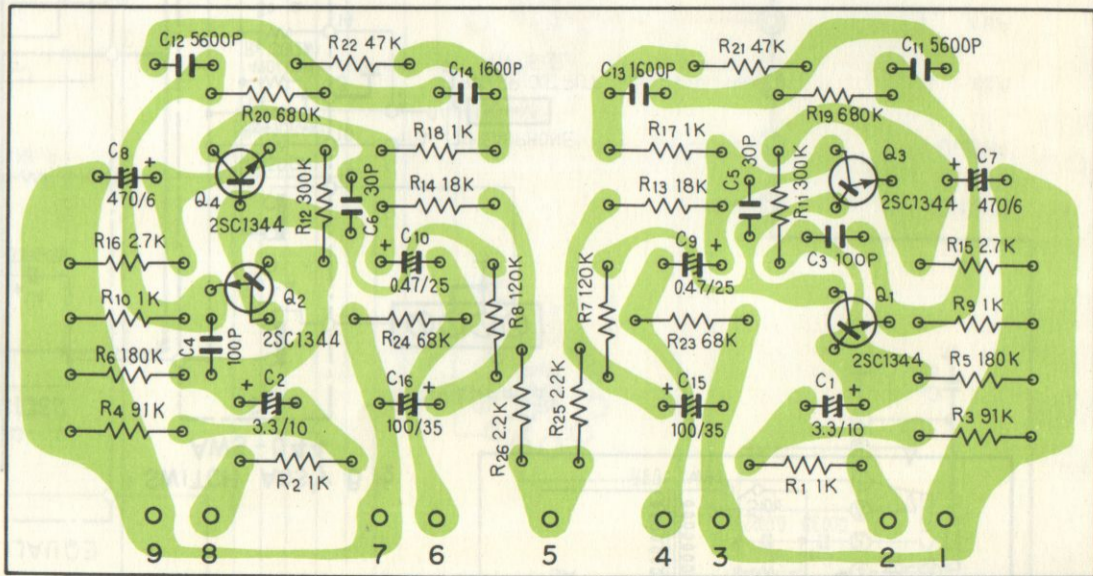

Power amp ass'y AWH-025

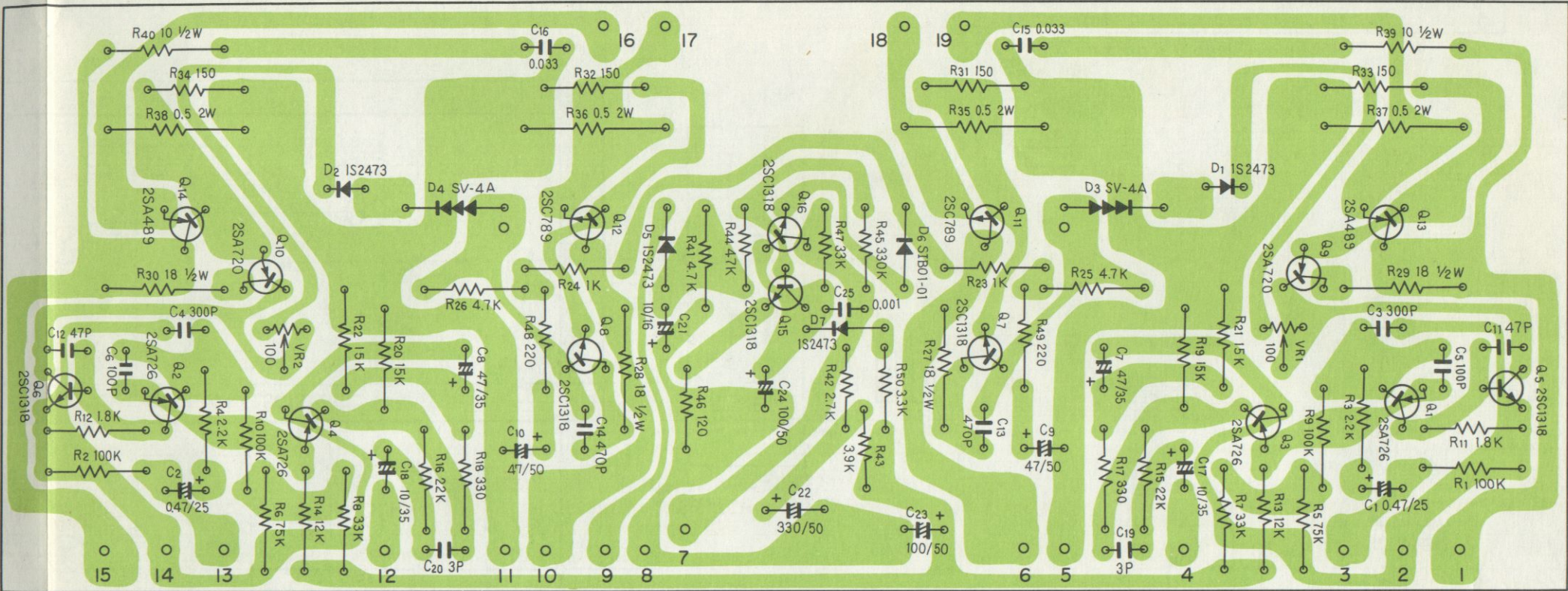

SWITCH ASS'y A 1/2 AWS-045

CONTROL AMP ASS'y AWG-020

- SWITCHES
- | | | | |
|----|-----------------|-----|-----------------------|
| S1 | SELECTOR | S7 | HIGH CUT FILTER |
| 1 | PHONO 2 / MIC | 1 | OFF |
| 2 | PHONO 1 | 2 | ON |
| 3 | TUNER | S8 | SPEAKERS A |
| 4 | AUX 1 | 1 | ON |
| 5 | AUX 2 | 2 | OFF |
| S2 | TAPE MONITOR 1 | S9 | SPEAKERS B |
| 1 | OFF | 1 | ON |
| 2 | ON | 2 | OFF |
| S3 | TAPE MONITOR 2 | S10 | POWER SWITCH |
| 1 | OFF | 1 | OFF |
| 2 | ON | 2 | ON |
| S4 | MODE SWITCH | S11 | LINE VOLTAGE SELECTOR |
| 1 | STEREO | 1 | 110V |
| 2 | MONO | 2 | 120V |
| S5 | LOUDNESS SWITCH | 3 | 130V |
| 1 | OFF | 4 | 220V |
| 2 | ON | 5 | 240V |
| S6 | MUTING SWITCH | | |
| 1 | OFF | | |
| 2 | ON | | |

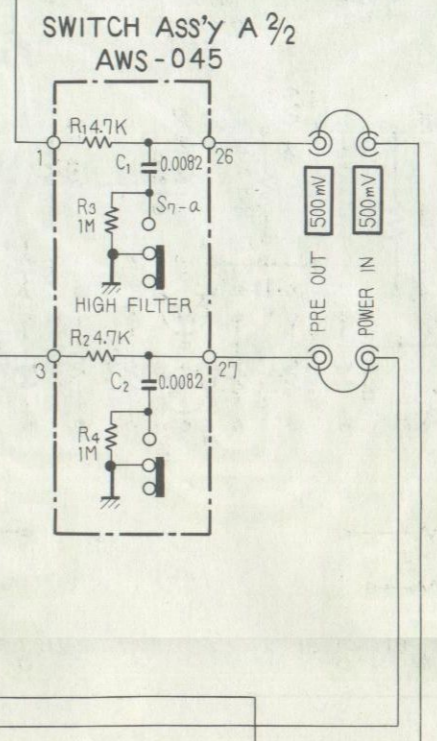
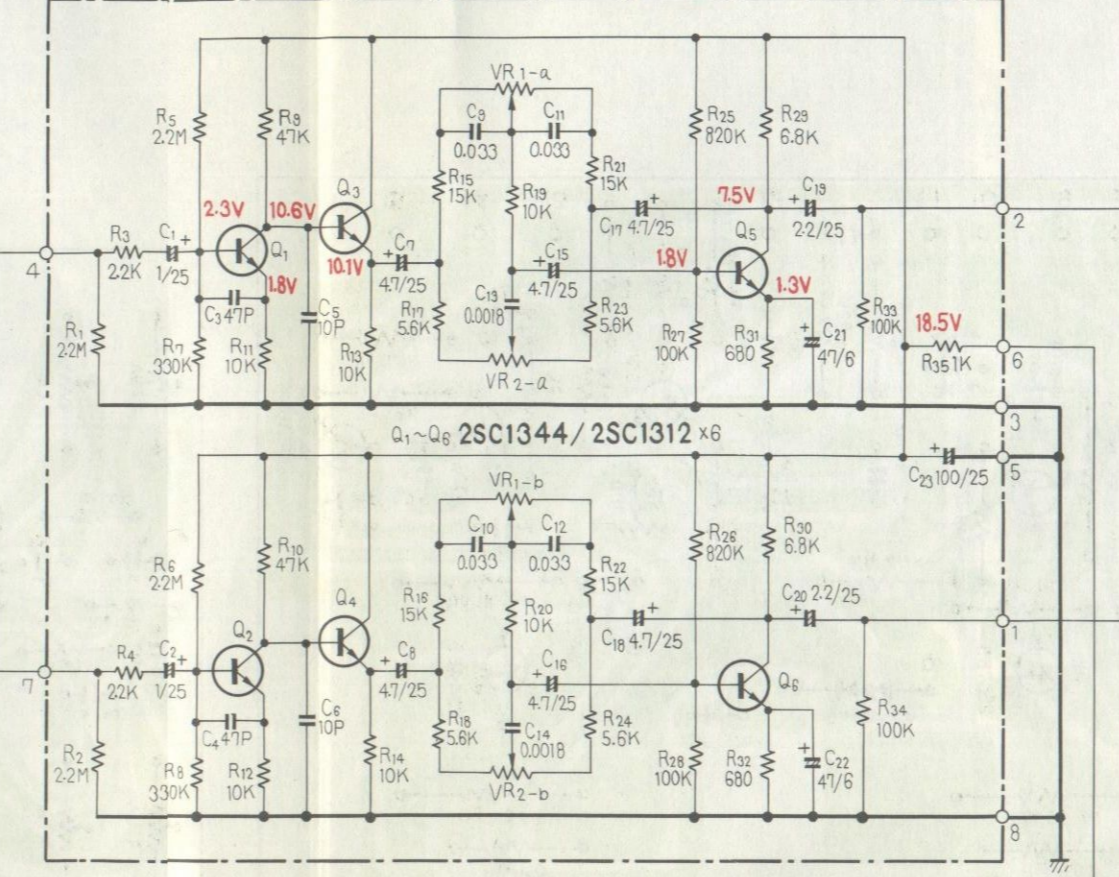
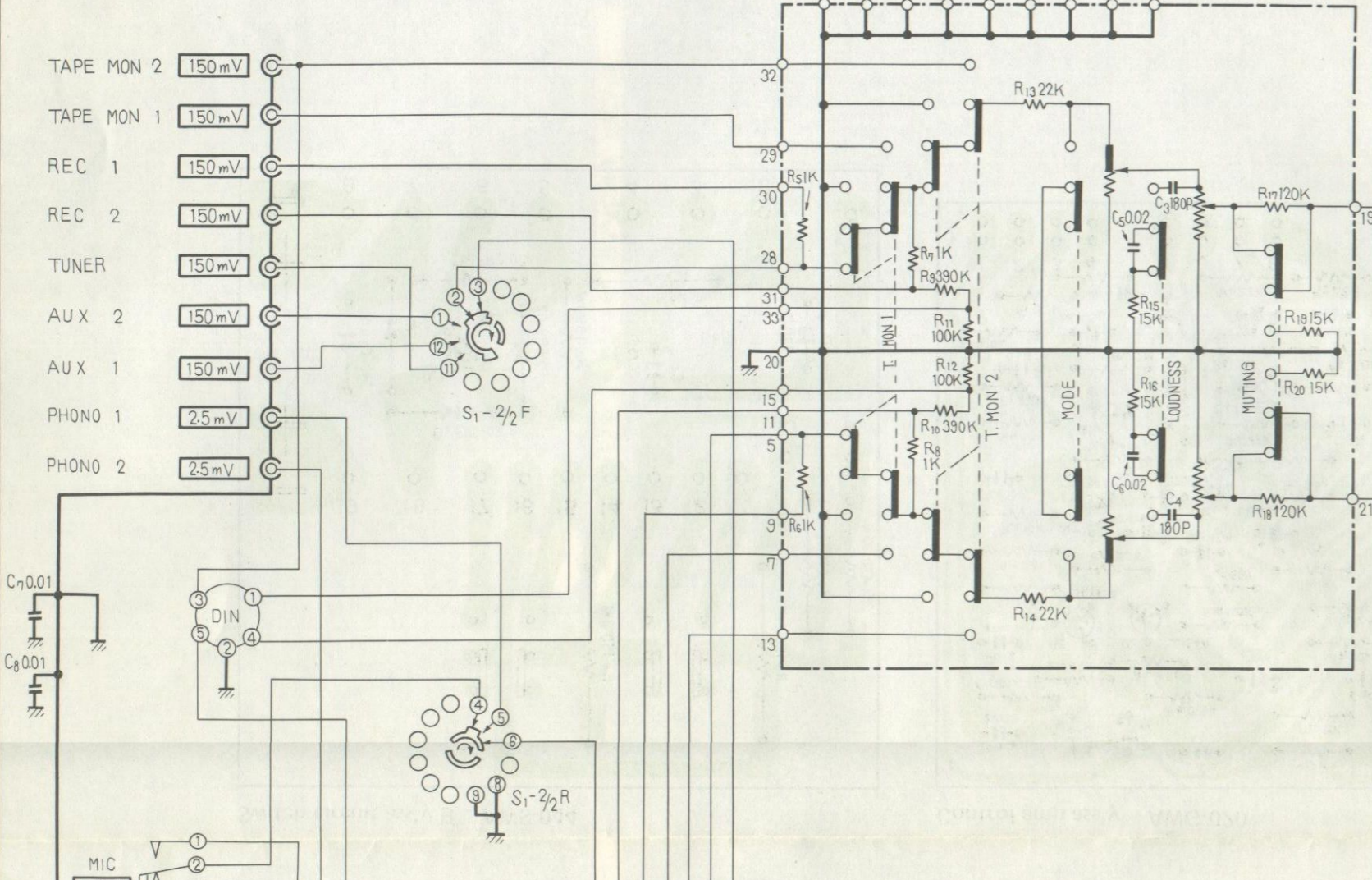

SIGNAL VOLTAGE AT 1kHz 22W/8Ω OUTPUT.
 DC VOLTAGE AT NO INPUT SIGNAL
 DC CURRENT AT NO INPUT SIGNAL

EQUALIZER AMP ASS'y AWF-008

POWER AMP ASS'y AWH-025

SWITCH ASS'y B 1/2 AWS-044

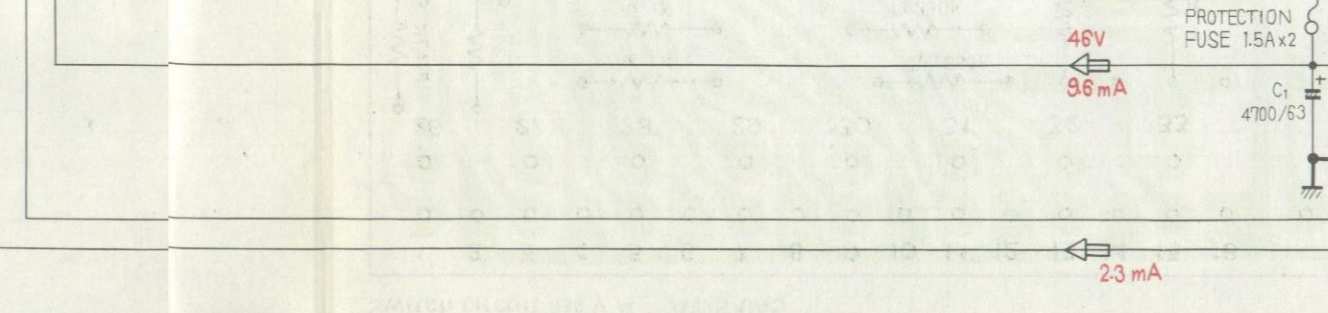
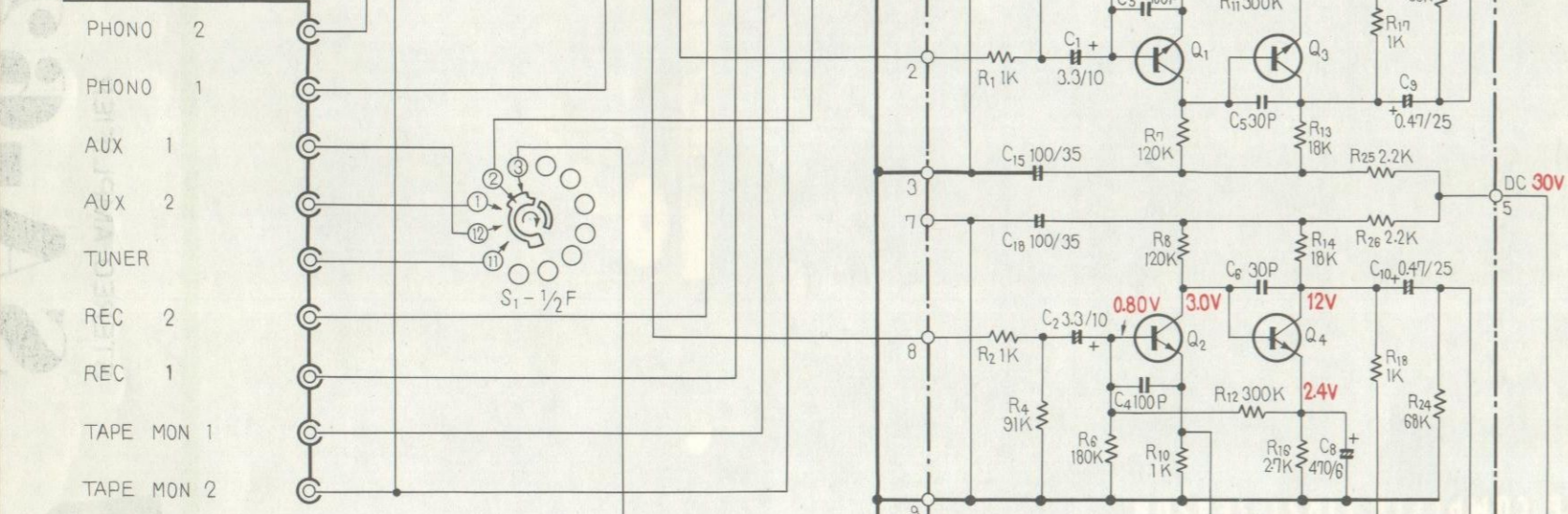
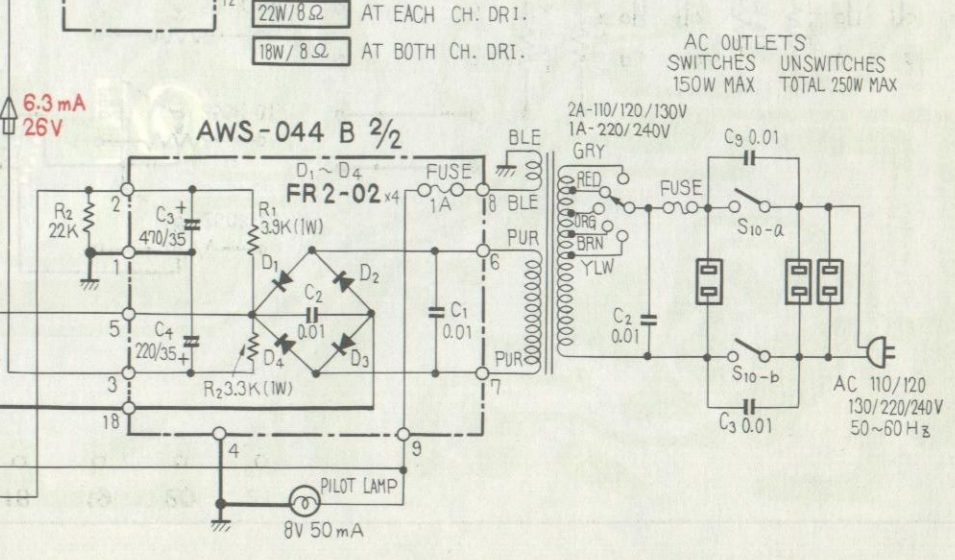
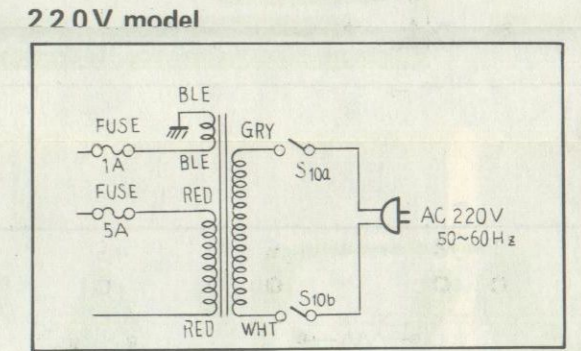
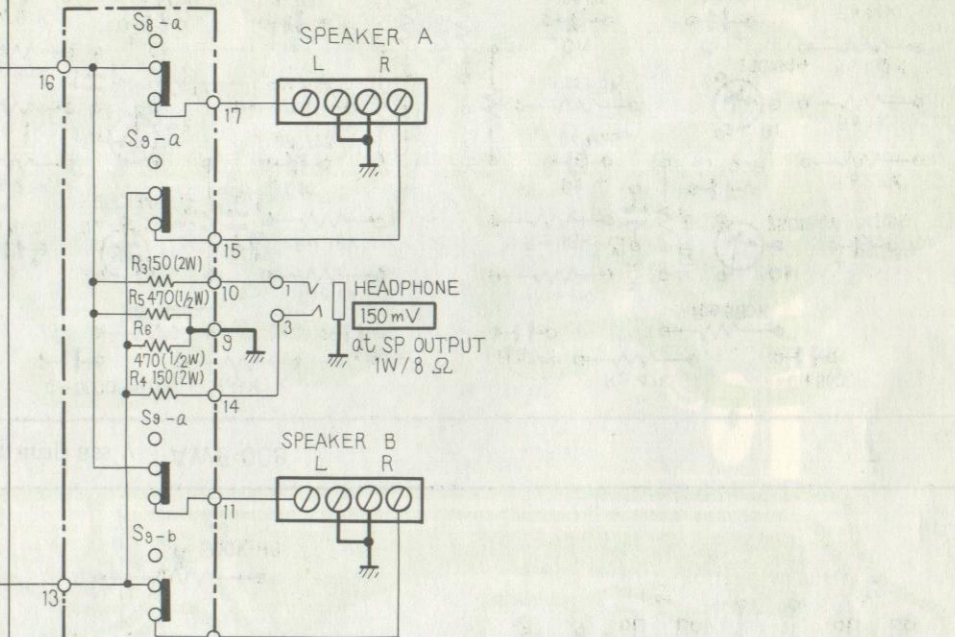
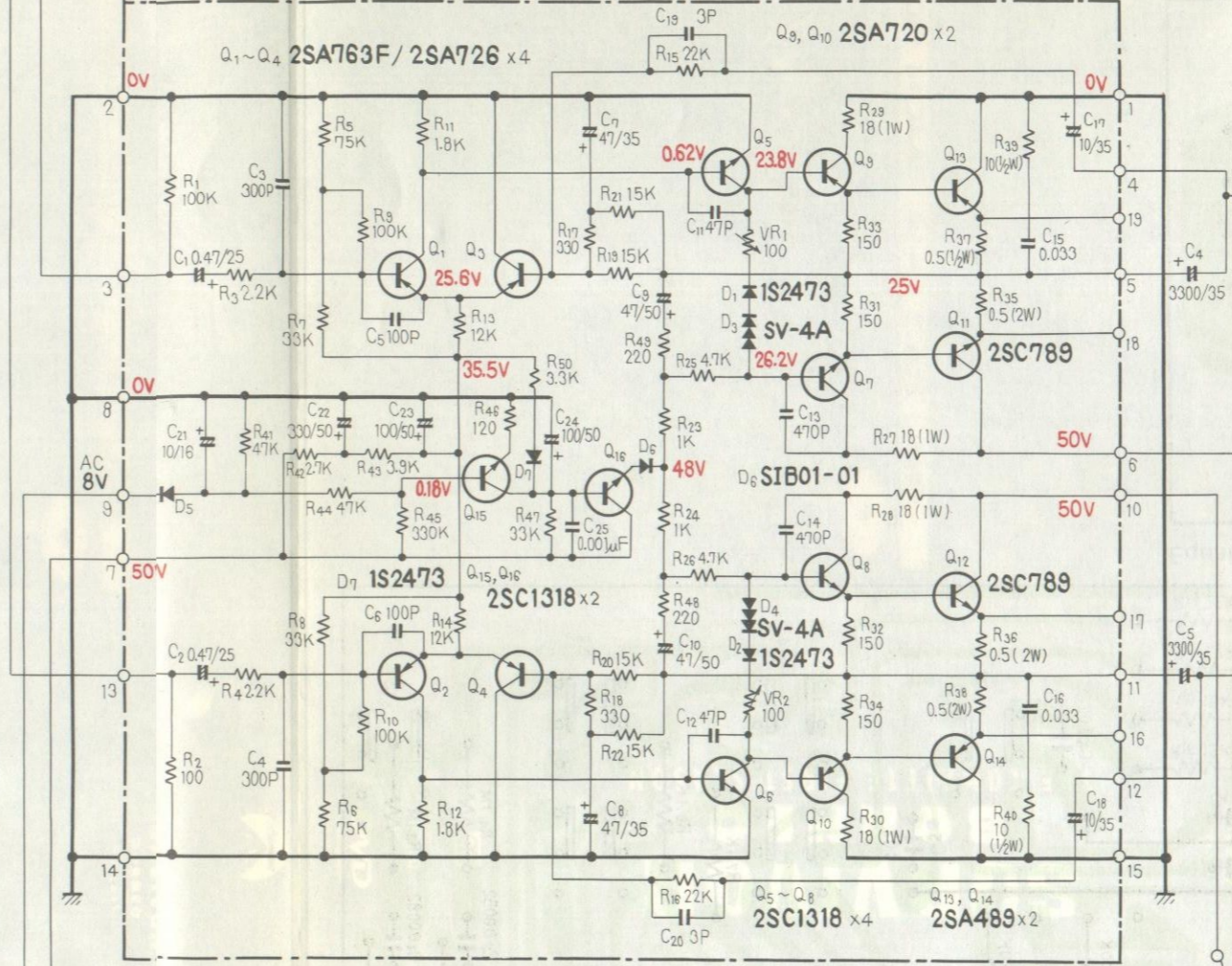
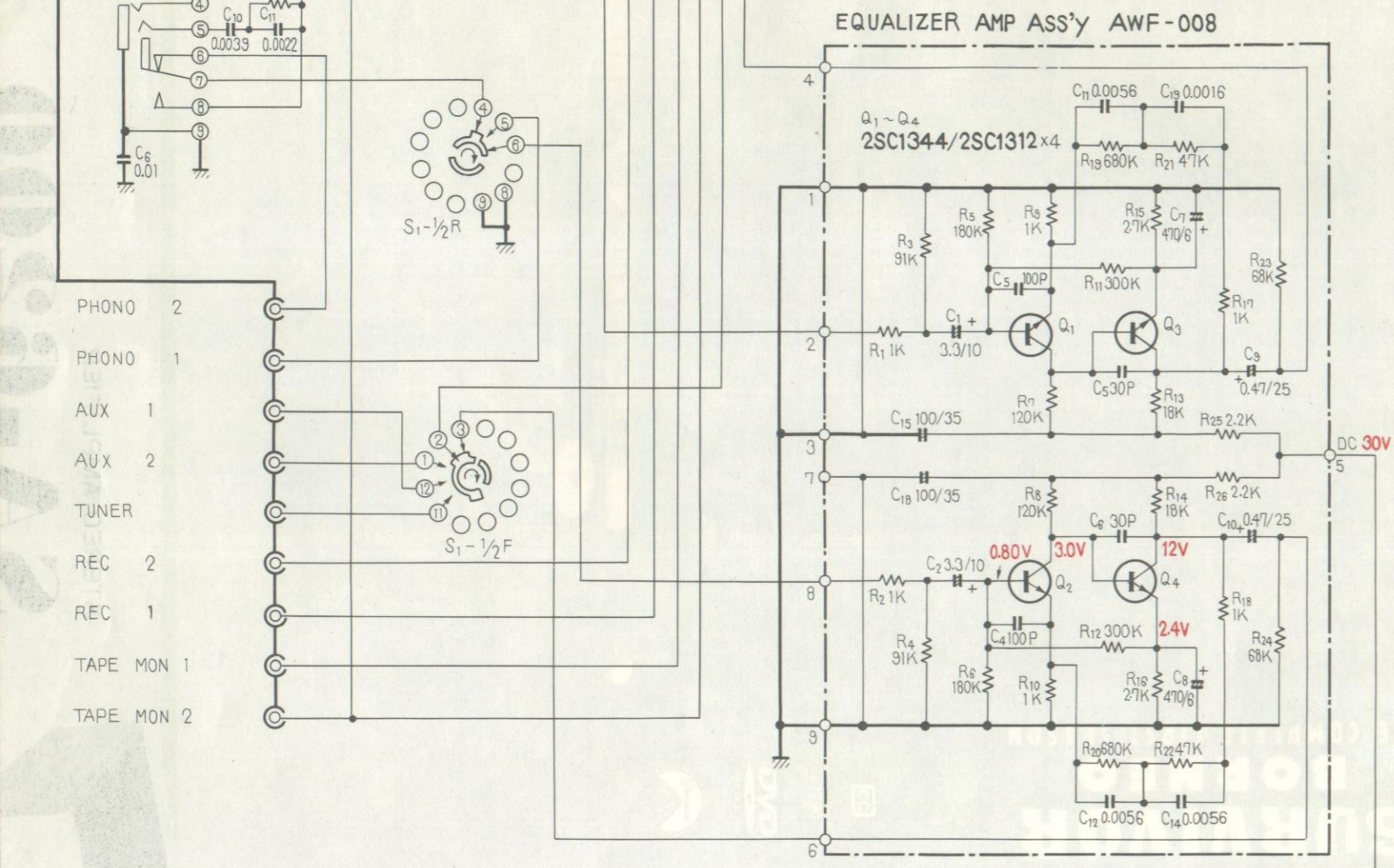

AC OUTLETS SWITCHES UNSWITCHES 150W MAX TOTAL 250W MAX